

Dear Business Partner;

We are happy to present our catalog with many new products.

As VIP-TEC family, our innovations will increase even more over time. At this point, our most important reference is the opinions and suggestions of our valued users.

Our aim is to help our professional users work fast, good and smart. We believe that pioneering, innovative and functional products should be accessible to everyone.

All of our products have been cleverly designed, well thought out and developed before the production phase, taking into account the areas of use. In return, the price level has always been affordable.

We will strive to be worthy of your trust and loyalty to the VIP-TEC brand.

Our aim is to contribute to our economy by producing high quality products for our country and world markets.

Best regards

AR METAL INC.

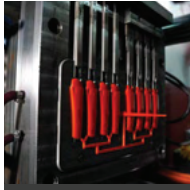

ANATOMY OF VIP-TEC UTILITY KNIFE

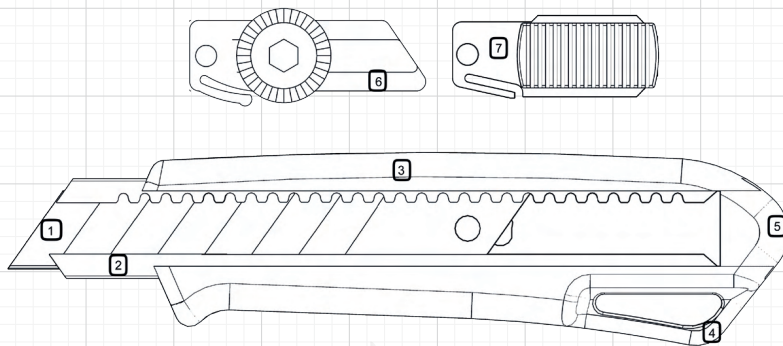

- 1 - More comfortable and professional cutting experience thanks to double grinding snap-off blade
- 2 - Safer cutting experience thanks to extended blade channel
- 3 - Ergonomic handle that provides comfortable grip with metal and plastic options
- 4 - Hangable body
- 5 - Portable cover designed for blade replacement
- 6 - Ratchet-Lock mechanism
- 7 - Auto-Lock mechanism

PRECISION

9 mm

- Nylon
- Cardboard
- Wallpaper
- Paper
- Caulking
- Plastic strip

HEAVY DUTY

18 mm

- Dry Wall
- Flooring
- Rubber
- Linoleum

EXTRA HEAVY DUTY

25 mm

- Rope
- High Pressure Laminates
- Expansion Plastics
- Upholstery



KATALOG



VIDEO

ANATOMY OF UTILITY KNIFE	02
USAGE RECOMMENDATIONS	04
18MM CUTTERS	05
9MM CUTTERS	19
INDUSTRIAL CUTTERS	25
SAFETY CUTTERS	35
OUTDOOR	42
STATIONERY - HOBBY	47
TRAPEZOID AND HOOK CUTTERS	58
SCRAPERS	61
BLACK SERIES	70
WHITE SERIES	73
SPARE BLADES	76
PACKAGING OPTIONS	86
COLOR OPTIONS	87
ICON DESCRIPTIONS	88
CERTIFICATES	89

USAGE RECOMMENDATIONS

RETRACT BLADE INTO HANDLE WHEN THE UTILITY KNIFE IS NOT IN USE.



Utility Knife Blade may cause an injury when it is the open mode. For that reason, we highly recommend you check your utility knife blade once you finish your cutting work and retract the blade into the utility knife handle when it is not in use.

DO NOT USE UTILITY KNIFE FOR THE IMPROPER PURPOSE.



Using your utility knife for improper purposes may lead to unwanted accidents. For that reason, we don't recommend using a utility knife as a scraper, screwdriver, chisel, or kitchen knife.

DO NOT TALK OR LOOK AWAY WHEN YOU CUT MATERIAL.



Cutting work requires all of your attention that's why you should focus on your cutting works and avoid talking and looking away.

CUT YOUR MATERIALS ON STABLE SURFACE.



Please pay attention to placing your cutting materials on a stable surface. Thus you could prevent yourself from any cut caused by any tilting or tipping of the materials.

USE A CUT-RESISTANT GLOVE.



We highly recommend you wear a cut-resistant glove in order to protect your hands from any cut or nick.

KEEP YOUR BODY AWAY FROM CUTTING LINE.



So many injuries happen when people keep their body and their other hand so close to the cutting line. We highly recommend you put enough distance between your body and cutting line in order to mitigate all risks that may arise from cut injuries. We also highly recommend you set the cutting line parallel to your body for your safety.

USE PLIER, GLOVE, AND GOGGLES WHEN BREAK OFF UTILITY KNIFE BLADE.



We highly recommend you use a plier for a safe break before you break off the utility knife blade. Thus you can grasp the knife more tightly and snap off the blade with less amount of force. In addition to plier, wearing gloves and goggles also enable us to perform cutting works with a higher degree of safety.

DISPOSE OF DULL BLADE AND BROKEN BLADE EDGE IN PUNCTURE-RESISTANT CONTAINER.



As we all know that utility knife blade is sharp and it may cause injuries if we don't store them carefully. In order not to cause any injury or accident, dull blades and broken blade edges must be disposed of in a puncture-resistant container.

MAKE SURE YOU USE RIGHT UTILITY KNIFE FOR YOUR CUTTING WORKS.



Using proper utility knife makes cutting work easier and safer. If you want to know which utility knife is the best for your cutting work please contact us.

18 MM CUTTERS



VT875101

DIMENSIONS (MM)
17x39x160

KNIFE CODE / SIZE (MM)
VT875000 / 0,5x18x100

COLOR OPTIONS

Blade Features: SK-3 Steel - 7 Segments - Double Cutting Edge

TECHNICAL FEATURES



AREAS OF USE



PACKAGING FEATURES

BOX
(SIZE - QUANTITY)
24,5x11x17 cm
36 Pieces

PARCEL
(SIZE - QUANTITY)
56x26x36 cm
360 Pieces

PALLET
(SIZE - QUANTITY)
120X80X122 cm
6480 Pieces



ERGONOMIC BODY

*Lightweight and durable thanks to double component plastic body made of ABS.



LOCKING MECHANISM

*The automatic locking mechanism ensures safe use by keeping the blade completely fixed and locked during the cutting process.

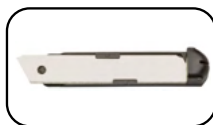

HANGER SLOT AND KNIFE SLOT

*There is a spare knife slot on the back cover.
*Easy to carry thanks to the hanger slot.



VT875103



VT875103V



ERGONOMIC BODY

*Lightweight and durable thanks to plastic body made of ABS.



LOCKING MECHANISM

*The automatic locking mechanism ensures safe use by keeping the blade completely fixed and locked during the cutting process.



LOCKING MECHANISM

*The screw lock mechanism allows the blade length to be adjusted at the desired level during the cutting process.

VT875103 - VT875103V

DIMENSIONS (MM)
17x39x160

KNIFE CODE / SIZE (MM)
VT875000 / 0,5x18x100

COLOR OPTIONS

Blade Features: VT875000: SK-3 Steel - 7 Segments - Double Cutting Edge

TECHNICAL FEATURES



AUTO-LOCK MECHANISM



SCREW LOCK



ABS PLASTIC



ERGONOMIC



HANGABLE



BREAKING OF BLADE

AREAS OF USE



WALL PAPER



DRYWALL



PLASTERBOARD



STYROFOAM



TEXTILE



PLASTIC ZIP TIE



STRETCH FILM



YARN



TAPE



SILICONE TIP CUTTING



AND MORE

PACKAGING FEATURES

BOX
(SIZE - QUANTITY)

24,5x11x17 cm
36 Pieces

PARCEL
(SIZE - QUANTITY)

56x26x36 cm
360 Pieces

PALLET
(SIZE - QUANTITY)

120X80X122 cm
6480 Pieces

VT875105

DIMENSIONS (MM)
17x41x160

KNIFE CODE / SIZE (MM)
VT875000 / 0,5x18x100

COLOR OPTIONS

Blade Features: SK-3 Steel - 7 Segments - Double Cutting Edge

TECHNICAL FEATURES



AUTO-LOCK MECHANISM



ABS PLASTIC



ERGONOMIC



HANGABLE

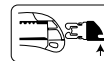

BREAKING OF BLADE

AREAS OF USE



WALL PAPER



DRYWALL



PLASTERBOARD



STYROFOAM



TEXTILE



PLASTIC ZIP TIE



STRETCH FILM



YARN



TAPE



SILICONE TIP CUTTING



AND MORE

PACKAGING FEATURES

BOX
(SIZE - QUANTITY)

24,5x11x17 cm

36 Pieces

PARCEL
(SIZE - QUANTITY)

56x26x36 cm

360 Pieces

PALLET
(SIZE - QUANTITY)

120x80x122 cm

6480 Pieces



ERGONOMIC BODY

*Lightweight and durable thanks to plastic body made of ABS.



LOCKING MECHANISM AND HANGER SLOT

*The automatic locking mechanism ensures safe use by keeping the blade completely fixed and locked during the cutting process.
*It is an easily portable product thanks to the hanger slot.



ERGONOMIC BODY

*Lightweight and durable thanks to plastic body made of ABS.



LOCKING MECHANISM AND HANGER SLOT

*The automatic locking mechanism ensures safe use by keeping the blade completely fixed and locked during the cutting process.
*It is an easily portable product thanks to the hanger slot.

VT875106

DIMENSIONS (MM)

16x40x160

KNIFE CODE / SIZE (MM)

VT875000 / 0,5x18x100

COLOR OPTIONS



Blade Features: SK-3 Steel - 7 Segments - Double Cutting Edge

TECHNICAL FEATURES



AUTO-LOCK MECHANISM



ABS PLASTIC



ERGONOMIC



HANGABLE

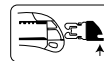

BREAKING OF BLADE

AREAS OF USE



WALL PAPER



DRYWALL



PLASTERBOARD



STYROFOAM



TEXTILE



PLASTIC ZIP TIE



STRETCH FILM



YARN



TAPE



SILICONE TIP CUTTING



AND MORE

PACKAGING FEATURES

BOX

(SIZE - QUANTITY)

24,5x11x17 cm

36 Pieces

PARCEL

(SIZE - QUANTITY)

56x26x36 cm

360 Pieces

PALLET

(SIZE - QUANTITY)

120X80X122 cm

6480 Pieces

VT875107

DIMENSIONS (MM)
15x29X165

KNIFE CODE / SIZE (MM)
VT875000 / 0,5x18x100

COLOR OPTIONS

Blade Features: SK-3 Steel - 14 Segments - Double Cutting Edge

TECHNICAL FEATURES



AUTO-LOCK
MECHANISM



ABS
PLASTIC



ERGONOMIC



BREAKING OF BLADE



HANGABLE



FOR BOTH
HANDS
CAN BE USED
WITH EITHER HAND

AREAS OF USE



WALL PAPER



DRYWALL



PLASTERBOARD



STYROFOAM



TEXTILE



PLASTIC
ZIP TIE



STRETCH FILM



YARN



TAPE



SILICONE TIP
CUTTING



AND MORE

PACKAGING FEATURES

BOX
(SIZE - QUANTITY)

24,5x11x17 cm
48 Pieces

PARCEL
(SIZE - QUANTITY)

56x26x36 cm
480 Pieces

PALLET
(SIZE - QUANTITY)

120X80X122 cm
8640 Pieces



ERGONOMIC BODY

*Lightweight and durable thanks to double component plastic body made of ABS.



LOCKING MECHANISM AND HANGER SLOT

*The automatic locking mechanism ensures safe use by keeping the blade completely fixed and locked during the cutting process.
*It is an easily portable product thanks to the hanger slot.



ALUMINUM METAL BODY

*Aluminum metal body is ergonomically designed for demanding cuts and long-term use.
*Corrosion resistant.
*Painted with electrostatic powder paint.



RUBBER COATING

*The rubber coating on the aluminum metal body provides a soft grip and prevents slipping.



LOCKING MECHANISM AND HANGER SLOT

*The automatic locking mechanism ensures safe use by keeping the blade completely fixed and locked during the cutting process.
*It is an easily portable product thanks to the hanger slot.

VT875109

DIMENSIONS (MM)
15x39x165

KNIFE CODE / SIZE (MM)
VT875000 / 0,5x18x100

COLOR OPTIONS

Blade Features: SK-3 Steel - 7 Segments - Double Cutting Edge

TECHNICAL FEATURES



AUTO-LOCK MECHANISM



METAL



RUBBER GRIP



ERGONOMIC



HANGABLE

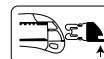

BREAKING OF BLADE

AREAS OF USE



WALL PAPER



DRYWALL



PLASTERBOARD



STYROFOAM



TEXTILE



PLASTIC ZIP TIE



STRETCH FILM



YARN



TAPE



SILICONE TIP CUTTING



AND MORE

PACKAGING FEATURES

BOX
(SIZE - QUANTITY)

24,5x11x17 cm

36 Pieces

PARCEL
(SIZE - QUANTITY)

36X26X34 cm

216 Pieces

PALLET
(SIZE - QUANTITY)

120X80X117 cm

5832 Pieces

VT875110

DIMENSIONS (MM)
15x39x165

KNIFE CODE / SIZE (MM)
VT875000 / 0,5x18x100

COLOR OPTIONS

Blade Features: SK-3 Steel - 7 Segments - Double Cutting Edge

TECHNICAL FEATURES

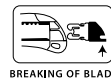

AREAS OF USE



PACKAGING FEATURES

BOX
(SIZE - QUANTITY)
24,5x11x17 cm
36 Pieces

PARCEL
(SIZE - QUANTITY)
36X26X34 cm
216 Pieces

PALLET
(SIZE - QUANTITY)
120X80X117 cm
5832 Pieces



ALUMINUM METAL BODY

*Aluminum metal body is ergonomically designed for demanding cuts and long-term use.
*Corrosion resistant.
*Painted with electrostatic powder paint.



LOCKING MECHANISM and HANGER SLOT

*The automatic locking mechanism ensures safe use by keeping the blade completely fixed and locked during the cutting process.
*It is an easily portable product thanks to the hanger slot.



VT875111



VT875111V

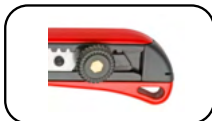

ALUMINUM METAL BODY

*Aluminum metal body is ergonomically designed for demanding cuts and long-term use.

*Corrosion resistant.

*Painted with electrostatic powder paint.

AUTOMATIC LOCKING AND HANGER SLOT

*The automatic locking mechanism ensures safe use by keeping the blade completely fixed and locked during the cutting process.

*It is an easily portable product thanks to the hanger slot.

SCREW LOCK

*The screw lock mechanism allows the blade length to be adjusted at the desired level during the cutting process.

VT875111 - VT875111V

DIMENSIONS (MM)

15x39x165

KNIFE CODE / SIZE (MM)

VT875000 / 0,5x18x100

COLOR OPTIONS



Blade Features: SK-3 Steel - 7 Segments - Double Cutting Edge

TECHNICAL FEATURES



AUTO-LOCK MECHANISM



SCREW LOCK



METAL



ERGONOMIC



HANGABLE

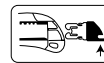

BREAKING OF BLADE

AREAS OF USE



WALL PAPER



DRYWALL



PLASTERBOARD



STYROFOAM



TEXTILE



PLASTIC ZIP TIE



STRETCH FILM



YARN



TAPE



SILICONE TIP CUTTING



AND MORE

PACKAGING FEATURES

BOX

(SIZE - QUANTITY)

24,5x11x17 cm

36 Pieces

PARCEL

(SIZE - QUANTITY)

56x26x36 cm

216 Pieces

PALLET

(SIZE - QUANTITY)

120X80X117 cm

5832 Pieces

VT875114

DIMENSIONS (MM)
16x36x160

KNIFE CODE / SIZE (MM)
VT875000 / 0,5x18x100

COLOR OPTIONS

Blade Features: SK-3 Steel - 7 Segments - Double Cutting Edge

TECHNICAL FEATURES



AUTO-LOCK MECHANISM



ABS PLASTIC



ERGONOMIC



HANGABLE



CAN BE USED WITH EITHER HAND



BREAKING OF BLADE

AREAS OF USE



WALL PAPER



DRYWALL



PLASTERBOARD



STYROFOAM



TEXTILE



PLASTIC ZIP TIE



STRETCH FILM



YARN



TAPE



SILICONE TIP CUTTING



AND MORE

PACKAGING FEATURES

BOX
(SIZE - QUANTITY)

24,5x11x17 cm
36 Pieces

PARCEL
(SIZE - QUANTITY)

56x26x36 cm
360 Pieces

PALLET
(SIZE - QUANTITY)

120X80X122 cm
6480 Pieces



ERGONOMIC BODY

*Lightweight and durable thanks to plastic body made of ABS.



LOCKING MECHANISM AND HANGER SLOT

*The automatic locking mechanism ensures safe use by keeping the blade completely fixed and locked during the cutting process.
*It is an easily portable product thanks to the hanger slot.

VT875115

DIMENSIONS (MM)
17x39x170

KNIFE CODE / SIZE (MM)
VT875000 / 0,5x18x100

COLOR OPTIONS

Blade Features: SK-3 Steel - 7 Segments - Double Cutting Edge

TECHNICAL FEATURES



AUTO-LOCK MECHANISM



ABS PLASTIC



ERGONOMIC



HANGABLE

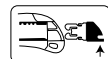

BREAKING OF BLADE

AREAS OF USE



WALL PAPER



DRYWALL



PLASTERBOARD



STYROFOAM



TEXTILE



PLASTIC ZIP TIE



STRETCH FILM



YARN



TAPE



SILICONE TIP CUTTING



AND MORE

PACKAGING FEATURES

BOX
(SIZE - QUANTITY)

24,5x11x17 cm
36 Pieces

PARCEL
(SIZE - QUANTITY)

56x26x36 cm
360 Pieces

PALLET
(SIZE - QUANTITY)

120X80X122 cm
6480 Pieces



ERGONOMIC BODY

*Lightweight and durable thanks to plastic body made of ABS.



LOCKING MECHANISM AND HANGER SLOT

*The automatic locking mechanism ensures safe use by keeping the blade completely fixed and locked during the cutting process.
*It is an easily portable product thanks to the hanger slot.



ALUMINUM METAL BODY

*Aluminum metal body is ergonomically designed for demanding cuts and long-term use.
*Corrosion resistant.
*Painted with electrostatic powder paint.



RUBBER COATING

*The rubber coating on the aluminum metal body provides a soft grip and prevents slipping.



LOCKING MECHANISM AND HANGER SLOT

*The automatic locking mechanism ensures safe use by keeping the blade completely fixed and locked during the cutting process.
*It is an easily portable product thanks to the hanger slot.

VT875117

DIMENSIONS (MM)
16x36x165

KNIFE CODE / SIZE (MM)
VT875000 / 0,5x18x100

COLOR OPTIONS
● ● ● ●

Blade Features: SK-3 Steel - 7 Segments - Double Cutting Edge

TECHNICAL FEATURES



AUTO-LOCK MECHANISM



METAL



RUBBER GRIP



ERGONOMIC



HANGABLE

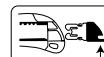

BREAKING OF BLADE

AREAS OF USE



WALL PAPER



DRYWALL



PLASTERBOARD



STYROFOAM



TEXTILE



PLASTIC ZIP TIE



STRETCH FILM



YARN



TAPE



SILICONE TIP CUTTING



AND MORE

PACKAGING FEATURES

BOX
(SIZE - QUANTITY)

24,5x11x17 cm
36 Pieces

PARCEL
(SIZE - QUANTITY)

36X26X34 cm
216 Pieces

PALLET
(SIZE - QUANTITY)

120X80X117 cm
5832 Pieces



ERGONOMIC BODY

*Lightweight and durable thanks to plastic body made of ABS.



LOCKING MECHANISM

*The automatic locking mechanism ensures safe use by keeping the blade completely fixed and locked during the cutting process.



REAR STOP

*The stop at the back prevents the mechanism from coming out of the slot.

VT875118

DIMENSIONS (MM)
13x28x160

KNIFE CODE / SIZE (MM)
VT875000 / 0,5x18x100

COLOR OPTIONS
● ● ● ●

Blade Features: SK-3 Steel - 7 Segments - Double Cutting Edge

TECHNICAL FEATURES



AUTO-LOCK MECHANISM



ABS PLASTIC



ERGONOMIC



CAN BE USED WITH EITHER HAND

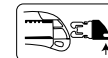

BREAKING OF BLADE

AREAS OF USE



WALL PAPER



DRYWALL



PLASTERBOARD



STYROFOAM



TEXTILE



PLASTIC ZIP TIE



STRETCH FILM



YARN



TAPE



SILICONE TIP CUTTING



AND MORE

PACKAGING FEATURES

BOX
(SIZE - QUANTITY)

24,5x11x17 cm
48 Pieces

PARCEL
(SIZE - QUANTITY)

56x26x36 cm
480 Pieces

PALLET
(SIZE - QUANTITY)

120X80X122 cm
8640 Pieces

VT875122

DIMENSIONS (MM)
17x39x165

KNIFE CODE / SIZE (MM)
VT875000 / 0,5x18x100

COLOR OPTIONS





Blade Features: SK-3 Steel - 7 Segments - Double Cutting Edge

TECHNICAL FEATURES



AREAS OF USE



PACKAGING FEATURES

BOX
(SIZE - QUANTITY)

24,5x11x17 cm
48 Pieces

PARCEL
(SIZE - QUANTITY)

56x26x36 cm
288 Pieces

PALLET
(SIZE - QUANTITY)

120X80X117 cm
7776 Pieces



ALUMINUM METAL BODY

*Aluminum metal body is ergonomically designed for demanding cuts and long-term use.
*Corrosion resistant.
*Painted with electrostatic powder paint.



LOCKING MECHANISM AND HANGER SLOT

*The automatic locking mechanism ensures safe use by keeping the blade completely fixed and locked during the cutting process.
*It is an easily portable product thanks to the hanger slot.

9 MM CUTTERS

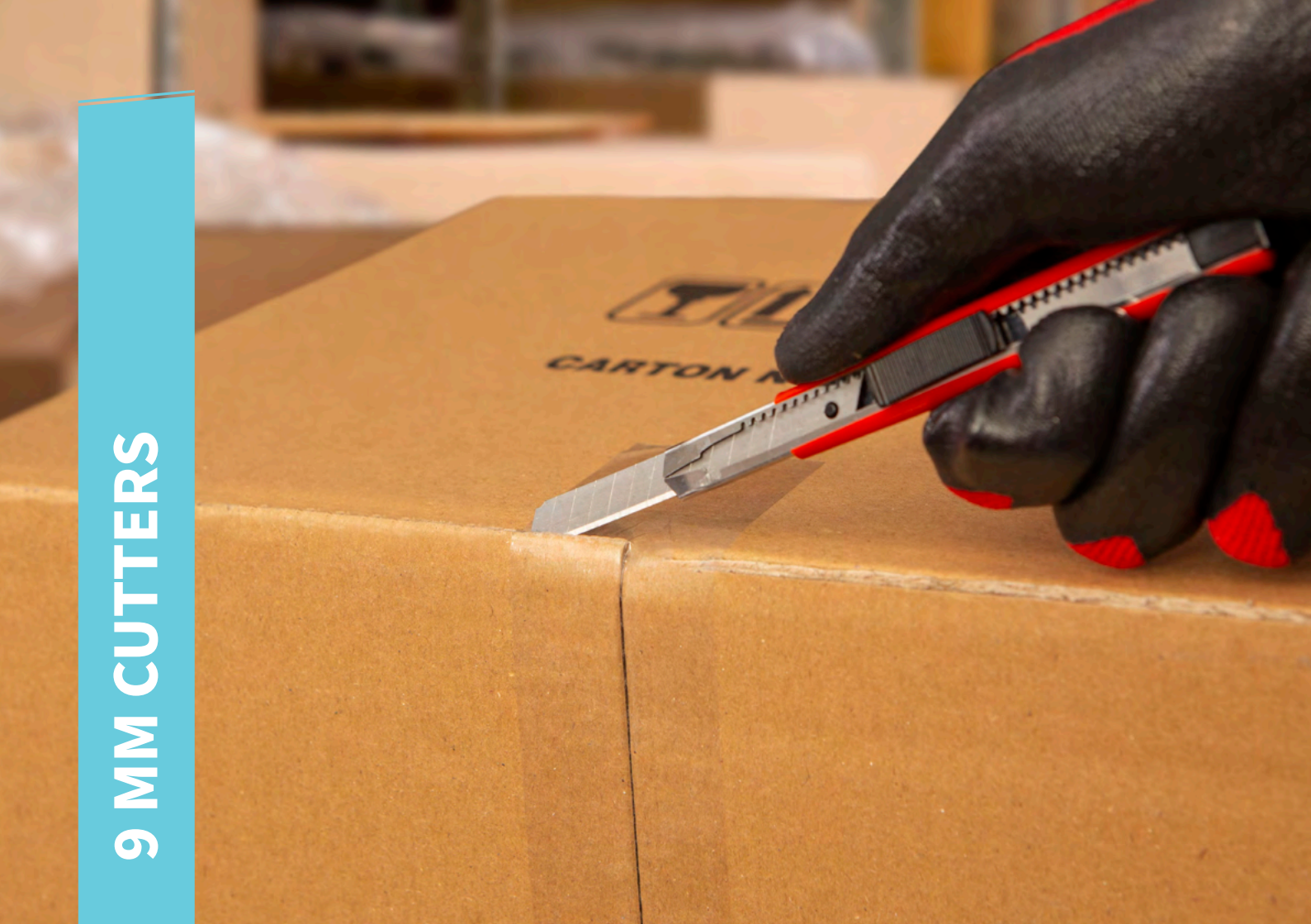

VT875102

DIMENSIONS (MM)
24x11x135

KNIFE CODE / SIZE (MM)
VT876000 / 0,4x9x80

COLOR OPTIONS

Blade Features: SK-3 Steel - 12 Segments - Double Cutting Edge

TECHNICAL FEATURES



AUTO-LOCK MECHANISM
CAN BE USED WITH EITHER HAND



ABS

ABS PLASTIC



ERGONOMIC



HANGABLE



CAN BE USED WITH EITHER HAND



BREAKING OF BLADE



STAINLESS STEEL

AREAS OF USE



PAPER



CARDBOARD



WINDOW FILM



BAGGED PRODUCTS



FOIL



YARN



HAND CRAFT FOIL



NYLON



BUBBLE WRAP



PLASTIC PACKAGE



RUBBER



AND MORE

PACKAGING FEATURES

BOX
(SIZE - QUANTITY)

19x18x15 cm
36 Pieces

PARCEL
(SIZE - QUANTITY)

56X39X31 cm
432 Pieces

PALLET
(SIZE - QUANTITY)

120x80x170 cm
8640 Pieces

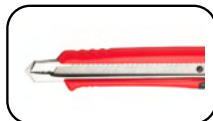

ERGONOMIC BODY

*Lightweight and durable thanks to double component plastic body made of ABS.



LOCKING MECHANISM AND HANGER SLOT

*The automatic locking mechanism ensures safe use by keeping the blade completely fixed and locked during the cutting process.
*It is an easily portable product thanks to the hanger slot.

VT875112

DIMENSIONS (MM)
24x11x140

KNIFE CODE / SIZE (MM)
VT876000 / 0,4x9x80

COLOR OPTIONS

Blade Features: SK-3 Steel - 12 Segments - Double Cutting Edge

TECHNICAL FEATURES



AUTO-LOCK MECHANISM



METAL



ERGONOMIC



HANGABLE



CAN BE USED WITH EITHER HAND

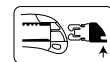

BREAKING OF BLADE

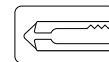

STAINLESS STEEL

AREAS OF USE



PAPER



CARDBOARD



WINDOW FILM



BAGGED PRODUCTS



FOIL



YARN



HAND CRAFT FOIL



NYLON



BUBBLE WRAP



PLASTIC PACKAGE



RUBBER



AND MORE

PACKAGING FEATURES

BOX
(SIZE - QUANTITY)

19x18x15 cm
36 Pieces

PARCEL
(SIZE - QUANTITY)

56X39X31 cm
432 Pieces

PALLET
(SIZE - QUANTITY)

120x80x170 cm
8640 Pieces



ALUMINUM METAL BODY

*Aluminum metal body is ergonomically designed for demanding cuts and long-term use.
*Corrosion resistant.
*Painted with electrostatic powder paint.



LOCKING MECHANISM AND HANGER SLOT

*The automatic locking mechanism ensures safe use by keeping the blade completely fixed and locked during the cutting process.
*It is an easily portable product thanks to the hanger slot.



STAINLESS STEEL BODY

*Stainless steel body provides light weight.
*Corrosion resistant.



LOCKING MECHANISM

*The automatic locking mechanism ensures safe use by keeping the blade completely fixed and locked during the cutting process.



CLIP

*The clip on the back section provides ease of access on carrying and blade breaking.

VT875113

DIMENSIONS (MM)

6x11x130

KNIFE CODE / SIZE (MM)

VT876000 / 0,4x9x80

Blade Features: SK-3 Steel - 12 Segments - Double Cutting Edge

TECHNICAL FEATURES



AUTO-LOCK MECHANISM



ERGONOMIC



CAN BE USED WITH EITHER HAND



CLIPS

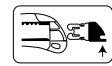

BREAKING OF BLADE

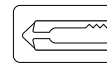

STAINLESS STEEL

AREAS OF USE



PAPER



CARDBOARD



WINDOW FILM



BAGGED PRODUCTS



FOIL



YARN



HAND CRAFT FOIL



NYLON



BUBBLE WRAP



PLASTIC PACKAGE



RUBBER



AND MORE

PACKAGING FEATURES

BOX

(SIZE - QUANTITY)

19x18x15 cm

36 Pieces

PARCEL

(SIZE - QUANTITY)

56X39X31 cm

432 Pieces

PALLET

(SIZE - QUANTITY)

120x80x170 cm

8640 Pieces

VT875119

DIMENSIONS (MM)
8x16x130

KNIFE CODE / SIZE (MM)
VT876000 / 0,4x9x80

COLOR OPTIONS

Blade Features: SK-3 Steel - 12 Segments - Double Cutting Edge

TECHNICAL FEATURES



AUTO-LOCK MECHANISM



ABS PLASTIC



ERGONOMIC



FOR BOTH HANDS
CAN BE USED WITH EITHER HAND



CLIPS

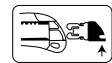

BREAKING OF BLADE

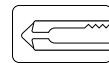

STAINLESS STEEL

AREAS OF USE



PAPER



CARDBOARD



WINDOW FILM



BAGGED PRODUCTS



FOIL



YARN



HAND CRAFT FOIL



NYLON



BUBBLE WRAP



PLASTIC PACKAGE



RUBBER



AND MORE

PACKAGING FEATURES

BOX
(SIZE - QUANTITY)

19x18x15 cm
36 Pieces

PARCEL
(SIZE - QUANTITY)

56X39X31 cm
432 Pieces

PALLET
(SIZE - QUANTITY)

120x80x170 cm
8640 Pieces

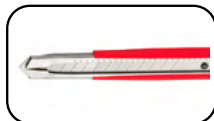

ERGONOMIC BODY

*ABS Plastic body provides light weight.
*Corrosion resistant.



LOCKING MECHANISM

*The automatic locking mechanism ensures safe use by keeping the blade completely fixed and locked during the cutting process.



CLIP

*The clip on the back section provides ease of use on carrying and blade breaking.

VT875124

DIMENSIONS (MM)

11x17x145

SIZE (MM)

0,4x9x72

Blade Features: SK-3 Steel - 6 Segments - Double Cutting Edge - 30 Degree Angle

TECHNICAL FEATURES



AUTO-LOCK
MECHANISM



METAL



ERGONOMIC



CLIPS

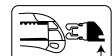

BREAKING OF BLADE

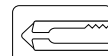

STAINLESS STEEL

AREAS OF USE



PAPER



CARDBOARD



WINDOW FILM



BAGGED
PRODUCTS



FOIL



YARN



HAND CRAFT
FOIL



NYLON



BUBBLE WRAP



PLASTIC
PACKAGE



RUBBER



AND MORE

PACKAGING FEATURES

BOX

(SIZE - QUANTITY)

16X11X20 cm

24 Pieces

PARCEL

(SIZE - QUANTITY)

56X39X31 cm

360 Pieces

PALLET

(SIZE - QUANTITY)

120X80X170 cm

7200 Pieces

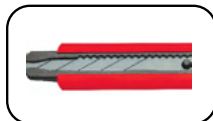

ERGONOMIC BODY

*Aluminum metal body is ergonomically designed for demanding cuts and long-term use.

*Corrosion resistant.



LOCKING MECHANISM

*The automatic locking mechanism ensures safe use by keeping the blade completely fixed and locked during the cutting process.



CLIP

*The clip on the back section provides ease of use on carrying and blade breaking.

INDUSTRIAL CUTTERS





VT875125



VT875125V

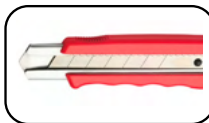

ERGONOMIC BODY

*ABS Plastic body provides light weight and durability.



LOCKING MECHANISM

*The automatic locking mechanism ensures safe use by keeping the blade completely fixed and locked during the cutting process.

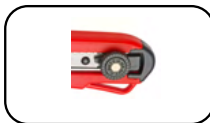

LOCKING MECHANISM

*The screw lock mechanism allows the blade length to be adjusted at the desired level during the cutting process.

VT875125 - VT875125V

DIMENSIONS (MM)

18x46x195

KNIFE CODE / SIZE (MM)

VT877000 / 0,7x25x125

COLOR OPTIONS



Blade Features: SK-2 Steel - 6 Segments - Double Cutting Edge

TECHNICAL FEATURES



AUTO-LOCK MECHANISM



ABS PLASTIC



PROFESSIONAL



ERGONOMIC



SCREW LOCK



HANGABLE

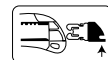

BREAKING OF BLADE

AREAS OF USE



PARQUET (HARDWOOD)



RUBBER



MEMBRANE



PLASTERBOARD



BASEBOARD



SHINGLE



VINYL



STYROFOAM



FELT



AND MORE

PACKAGING FEATURES

BOX

(SIZE - QUANTITY)

28X18X16,5 cm

36 Pieces

PARCEL

(SIZE - QUANTITY)

58X38X35 cm

288 Pieces

PALLET

(SIZE - QUANTITY)

120X80X155 cm

4608 Pieces

VT875127

DIMENSIONS (MM)

14x48x90

KNIFE CODE / SIZE (MM)

VT875005-1 / 0,8x40x90

COLOR OPTIONS



Blade Features: SK-5 Steel - Hook

TECHNICAL FEATURES



SCREW LOCK



ABS PLASTIC



ERGONOMIC



HANGABLE

AREAS OF USE



CARPET



PVC



SHINGLE



VINYL



MEMBRANE



AND MORE

PACKAGING FEATURES

BOX

(SIZE - QUANTITY)

24,5x11x17 cm

36 Pieces

PARCEL

(SIZE - QUANTITY)

56x26x36 cm

360 Pieces

PALLET

(SIZE - QUANTITY)

120X80X122 cm

6480 Pieces



LOCKING MECHANISM

*The screw lock mechanism allows the blade length to be adjusted at the desired level during the cutting process.



ERGONOMIC BODY

*ABS Plastic body provides light weight and durability.



HANGER SLOT

It is an easily portable product thanks to its hanger slot.



SERRATED BLADE

*Serrated blade with one serrated edge to help prevent slipping while cutting.



OVAL NOTCH

*The upper part of the blade is designed for heavy industrial applications.



STAINLESS STEEL BLADE

*Stainless steel blades are long lasting and corrosion resistant.



HOLDING HANDLE

*The ABS Plastic handle makes it lightweight and easy to use for long periods of time.

VT875161

DIMENSIONS (MM)

L: 141mm

Blade Features: Stainless Steel

TECHNICAL FEATURES



ABS PLASTIC



ERGONOMIC



CAN BE USED WITH EITHER HAND



STAINLESS STEEL

AREAS OF USE



LEATHER



YARN



PAPER



CARDBOARD



TEXTILE



AND MORE

PACKAGING FEATURES

BOX
(SIZE - QUANTITY)

24,5x11x17 cm

12 Pieces

PARCEL
(SIZE - QUANTITY)

56x26x36 cm

120 Pieces

PALLET
(SIZE - QUANTITY)

120X80X122 cm

2160 Pieces

VT875162



SERRATED BLADE
*Serrated blade with one serrated edge to help prevent slipping while cutting.



OVAL NOTCH
*The upper part of the blade is designed for heavy industrial applications.



STAINLESS STEEL BLADE
*Stainless steel blades are long lasting and corrosion resistant.



HOLDING HANDLE
*Lightweight, long-lasting and ergonomic use thanks to the rubber coated handle on ABS Plastic.

DIMENSIONS (MM)

L: 146mm

Blade Features: Stainless Steel

TECHNICAL FEATURES

ABS

ABS PLASTIC

RUBBER GRIP

RUBBER GRIP

ERGONOMIC

ERGONOMIC

FOR BOTH

CAN BE USED WITH EITHER HAND

STAINLESS STEEL

STAINLESS STEEL

AREAS OF USE

LEATHER

LEATHER

YARN

YARN

PAPER

PAPER

CABLE INSULATION CUTTING

CABLE INSULATION CUTTING

CARDBOARD

CARDBOARD

TEXTILE

TEXTILE

+

AND MORE

PACKAGING FEATURES

BOX

(SIZE - QUANTITY)

19x10x19 cm

12 Pieces

PARCEL

(SIZE - QUANTITY)

46x30x39 cm

144 Pieces

PALLET

(SIZE - QUANTITY)

120X80X134 cm

2592 Pieces



SERRATED BLADE

*Serrated blade with one serrated edge to help prevent slipping while cutting.



STAINLESS STEEL BLADE

*Stainless steel blades are long lasting and corrosion resistant.

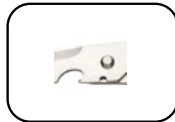

NOTCHES

*The large section is designed for opening bottle caps etc. and the small section for cutting thin iron wires.



HOLDING HANDLE

*Lightweight, long-lasting and ergonomic use thanks to the rubber coated handle on ABS Plastic.

VT875163

DIMENSIONS (MM)

L: 220mm

Blade Features: Stainless Steel

TECHNICAL FEATURES



ABS PLASTIC



RUBBER GRIP



ERGONOMIC



CAN BE USED WITH EITHER HAND



STAINLESS STEEL

AREAS OF USE



LEATHER



YARN



PAPER



CARDBOARD



TEXTILE



AND MORE

PACKAGING FEATURES

BOX

(SIZE - QUANTITY)

25X12X33 cm

24 Pieces

PARCEL

(SIZE - QUANTITY)

38X38X34 cm

96 Pieces

PALLET

(SIZE - QUANTITY)

120X80X150 cm

2304 Pieces



LONG BLADE

*Provides ease of precision cutting thanks to its long blades.



STAINLESS STEEL BLADE

*Corrosion resistant with long-term cutting ability.



HOLDING HANDLE

*Round and long handles for secure grip and easy handling.

VT875164

DIMENSIONS (MM)

L: 240mm

Blade Features: Stainless Steel

TECHNICAL FEATURES



ABS PLASTIC



ERGONOMIC



CAN BE USED WITH EITHER HAND



STAINLESS STEEL

AREAS OF USE



LEATHER



YARN



PAPER



CARDBOARD



TEXTILE



AND MORE

PACKAGING FEATURES

BOX

(SIZE - QUANTITY)

29X10X36 cm

24 Pieces

PARCEL

(SIZE - QUANTITY)

46X30X39 cm

96 Pieces

PALLET

(SIZE - QUANTITY)

120X80X134 cm

1728 Pieces

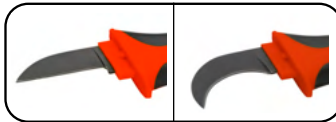

STAINLESS STEEL BLADE
*Sharp and corrosion resistant.



ERGONOMIC BODY
*Easy to use thanks to the rubber coating on ABS Plastic.

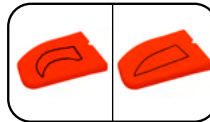

PROTECTIVE COVER
*Ensures that the insert is not damaged and increases safety.

VT875180 - VT875181

DIMENSIONS (MM)
18x28x180

Blade Features: Flat / Hook

TECHNICAL FEATURES



AREAS OF USE



PACKAGING FEATURES

BOX
(SIZE - QUANTITY)
15X13,5x26,5 cm
12 Pieces

PARCEL
(SIZE - QUANTITY)
46X30X39 cm
96 Pieces

PALLET
(SIZE - QUANTITY)
120X80X134 cm
1728 Pieces



CUTTER

*Double-sided cutting tip makes it easy to cut different materials.



CABLE STRIPPING

*Provides precise, fast and safe stripping of all round cables stripping between 4-28 mm.
*Built-in, self-rotating cutter for internal and longitudinal cuts.



ERGONOMIC BODY

*Lightweight and durable thanks to the ABS double component body.

VT209200

DIMENSIONS (MM)

20x27x180

Blade Features: Flat and Hook

TECHNICAL FEATURES



ABS PLASTIC



PROFESSIONAL



ERGONOMIC



CAN BE USED WITH EITHER HAND

AREAS OF USE



CABLE INSULATION CUTTING



AND MORE

PACKAGING FEATURES

BOX
(SIZE - QUANTITY)

26,5x11x7,5 cm

12 Pieces

PARCEL
(SIZE - QUANTITY)

46X30X39 cm

240 Pieces

PALLET
(SIZE - QUANTITY)

120X80X134 cm

4320 Pieces



VT217140



VT217160



CUTTER

*The steel tip has high hardness and is robust and durable.



PLASTIC HANDLE

*Thanks to its plastic handle, it is comfortable to hold and suitable for working for long periods of time.

VT217140 – VT217160

DIMENSIONS (MM)

L:140 / L:160 mm

Blade Features: Steel

TECHNICAL FEATURES



METAL



ERGONOMIC



CAN BE USED WITH EITHER HAND

AREAS OF USE



CABLE INSULATION CUTTING



AND MORE

PACKAGING FEATURES

BOX
(SIZE - QUANTITY)

23,5x11x4 cm
6 Pieces

PARCEL
(SIZE - QUANTITY)

46x30x25 cm
180 Pieces

PALLET
(SIZE - QUANTITY)

120x80x115 cm
4320 Pieces

SAFETY CUTTERS





VT875104



VT875120

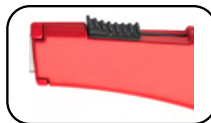

SAFETY

*Thanks to the automatic spring system, the blade automatically retracts when the hand is removed from the slide.



BODY

*Aluminum body has a long-lasting and corrosion-resistant structure.

VT875104 - VT875120

DIMENSIONS (MM)

18x45x150

KNIFE CODE / SIZE (MM)

VT874000 / 0,6x19x60
VT874001 / 0,6x19x48

COLOR OPTIONS



Blade Features: SK-2 Steel - Trapezoid/Hook - Double Cutting Edge

TECHNICAL FEATURES



METAL



AUTOMATIC SLIDE BACK



SAFETY



ERGONOMIC



18mm
DEPTH OF CUT
TRAPEZOID



16mm
DEPTH OF CUT
HOOKED



HANGABLE



CAN BE USED
WITH EITHER HAND

AREAS OF USE



CARPET



LEATHER



CARDBOARD



TEXTILE



PIPE



UPHOLSTERY



MEMBRANE



AND MORE

PACKAGING FEATURES

BOX

(SIZE - QUANTITY)

24,5x11x17 cm

36 Pieces

PARCEL

(SIZE - QUANTITY)

36X26X34 cm

216 Pieces

PALLET

(SIZE - QUANTITY)

120X80X117 cm

5832 Pieces



ERGONOMIC BODY
*It has a light and durable structure thanks to its ABS Plastic body.







SAFETY
*Thanks to the automatic spring system, the blade automatically retracts when the hand is removed from the slide.









HANGER SLOT
It is an easily portable product thanks to its hanger slot.

VT875116

DIMENSIONS (MM) 17x34x145	KNIFE CODE / SIZE (MM) VT874000 / 0,6x19x60	COLOR OPTIONS    
-------------------------------------	-------------------------------------------------------	-------------------------------------------------------------------------------------------------------------------------------------------------------------------------------------------------------------------------------------------------------------------------------------------------------------------------------------------------------------------------

Blade Features: SK-2 Steel - Trapezoid - Double Cutting Edge

TECHNICAL FEATURES

 ABS ABS PLASTIC	 QUICK RETURN 1 IN 10 MM AUTOMATIC SLIDE BACK	 SAFETY
 ERGONOMIC	 18mm DEPTH OF CUT TRAPEZOID	 HANGABLE

AREAS OF USE

 CARPET	 LEATHER	 CARDBOARD	 TEXTILE
 PIPE	 UPHOLSTERY	 BAGGED PRODUCTS	 AND MORE

PACKAGING FEATURES

BOX (SIZE - QUANTITY)	PARCEL (SIZE - QUANTITY)	PALLET (SIZE - QUANTITY)
24,5x11x17 cm 36 Pieces	56x26x36 cm 360 Pieces	120X80X122 cm 6480 Pieces



BLADE LENGTH

* It allows you to make deeper cuts thanks to its 60mm blade.



SAFETY

*Thanks to the automatic spring system, the blade automatically retracts when the hand is removed from the slide.



HANGER SLOT

*It is an easily portable product thanks to its hanger slot.

VT875116L

DIMENSIONS (MM)
17x34x145

KNIFE CODE / SIZE (MM)
VT874000L / 0,5x18x60

COLOR OPTIONS
● ● ● ●

Blade Features: SK-2 Steel - Trapezoid - Double Cutting Edge - Long

TECHNICAL FEATURES



ABS PLASTIC



AUTOMATIC SLIDE BACK



SAFETY



ERGONOMIC



DEPTH OF CUT 116L



HANGABLE

AREAS OF USE



CARPET



LEATHER



CARDBOARD



TEXTILE



PIPE



UPHOLSTERY



BAGGED PRODUCTS



AND MORE

PACKAGING FEATURES

BOX
(SIZE - QUANTITY)

24,5x11x17 cm
36 Pieces

PARCEL
(SIZE - QUANTITY)

56x26x36 cm
360 Pieces

PALLET
(SIZE - QUANTITY)

120X80X122 cm
6480 Pieces

VT875126Y

DIMENSIONS (MM)

L:195

KNIFE CODE / SIZE (MM)

VT874000 / 0,6x19x60

COLOR OPTIONS



Blade Features: SK-2 Steel - Trapezoid - Double Cutting Edge

TECHNICAL FEATURES



ABS PLASTIC



SAFETY



ERGONOMIC



HANGABLE



CAN BE USED WITH EITHER HAND

AREAS OF USE



CARDBOARD



PLASTIC ZIP TIE



BUBBLE WRAP



YARN



STRETCH FILM



AND MORE

PACKAGING FEATURES

BOX

(SIZE - QUANTITY)

24X17X9 cm

12 Pieces

PARCEL

(SIZE - QUANTITY)

58X38X35 cm

216 Pieces

PALLET

(SIZE - QUANTITY)

120X80X155 cm

3456 Pieces



NOTCH

*With the protrusion on the top, holes can be made for packaged products.



CORNERS

*Thanks to the sharp protrusions on the edges, it provides ease of cutting through the hole opened.



USAGE

*Can be used bilaterally thanks to its symmetrical design. Suitable for right and left hand use.



SPARE SECTION

*2 spare blades can be stored in the pull out cover.

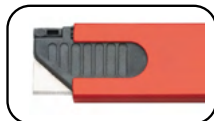
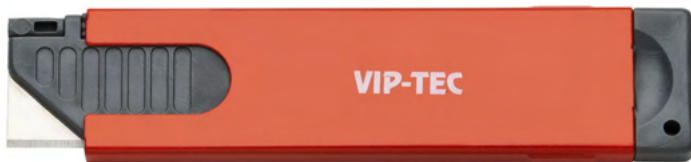

USE

*Suitable for right and left hand use thanks to the double-sided spike.



BODY

*Aluminum body increases durability. Small and lightweight design provides ease of transportation.



CUTTER TIP

*Double-sided sharpening provides four-sided use.

VT875156

DIMENSIONS (MM)

7x25x100

KNIFE CODE / SIZE (MM)

VT877020 / 0,3x19x40

Blade Features: SK-2 Steel - Four Side Cutting Edge

TECHNICAL FEATURES



METAL



QUICK RETURN
AUTOMATIC
SLIDE BACK



SAFETY



ERGONOMIC



14mm
DEPTH OF CUT
VT877020



FOR BOTH
HANDS
CAN BE USED
WITH EITHER HAND

AREAS OF USE



PAPER



CARDBOARD



TEXTILE



PLASTIC
PACKAGE



BUBBLE WRAP



STRETCH FILM



TAPE



AND MORE

PACKAGING FEATURES

BOX

(SIZE - QUANTITY)

19X12X9 cm

72 Pieces

PARCEL

(SIZE - QUANTITY)

37X26X19 cm

432 Pieces

PALLET

(SIZE - QUANTITY)

120X80X110 cm

17280 Pieces



USE

*The round compartment on the top is designed for finger use in emergencies.



DESIGN

*The blade gap on the product is specially designed for seat belts.

VT875200

DIMENSIONS (MM)

6x44x123

TECHNICAL FEATURES



ABS PLASTIC



SAFETY



ERGONOMIC



HANGABLE



CAN BE USED WITH EITHER HAND

AREAS OF USE



SEAT BELT



BAGGED PRODUCTS



STRETCH FILM



AND MORE

PACKAGING FEATURES

BOX
(SIZE - QUANTITY)

24,5x11x17 cm
36 Pieces

PARCEL
(SIZE - QUANTITY)

56x26x36 cm
360 Pieces

PALLET
(SIZE - QUANTITY)

120X80X122 cm
6480 Pieces

OUTDOOR



VT875111T

DIMENSIONS (MM)
15x39x165

KNIFE CODE / SIZE (MM)
VT875003-2 / 0,5x18x100

COLOR OPTIONS

Blade Features: SK-5 Steel - 7 Segments - Serrated

TECHNICAL FEATURES



SCREW LOCK



METAL



ERGONOMIC



HANGABLE

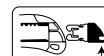

BREAKING OF BLADE

AREAS OF USE



PARQUET
(HARDWOOD)



RUBBER



FELT



PLASTERBOARD



DRYWALL



PLASTIC PIPE



BASEBOARD



PIPE



TARPAULIN



AND MORE

PACKAGING FEATURES

BOX
(SIZE - QUANTITY)

24,5x11x17 cm
36 Pieces

PARCEL
(SIZE - QUANTITY)

36x26x34 cm
216 Pieces

PALLET
(SIZE - QUANTITY)

120X80X117 cm
5832 Pieces



BLADE

*Suitable for tough cuts thanks to its snap off, serrated blade.



ALUMINUM METAL BODY

*Aluminum metal body, ergonomically designed for tough cuts, long term use.
*Corrosion resistant.
*Painted with electrostatic powder paint.



LOCK MECHANISM

*The screw lock mechanism allows the blade length to be adjusted to the desired level during the cutting process.



HANGER SLOT

*It is an easy-to-carry product thanks to its hanging slot.







VT875115T











DIMENSIONS (MM) 17x39x170	KNIFE CODE / SIZE (MM) VT875003-1 / 0,5x18x100	COLOR OPTIONS ● ● ● ●
-------------------------------------	----------------------------------------------------------	---------------------------------

Blade Features: SK-5 Steel - Serrated

TECHNICAL FEATURES

 SCREW LOCK	 ABS PLASTIC	 ERGONOMIC
 HANGABLE	 BREAKING OF BLADE	

AREAS OF USE

 PARQUET (HARDWOOD)	 RUBBER	 FELT	 PLASTERBOARD	 DRYWALL
 PLASTIC PIPE	 BASEBOARD	 PIPE	 TARPAULIN	 AND MORE

PACKAGING FEATURES

BOX (SIZE - QUANTITY)	PARCEL (SIZE - QUANTITY)	PALLET (SIZE - QUANTITY)
24,5x11x17 cm 36 Pieces	56x26x36 cm 360 Pieces	120X80X122 cm 6480 Pieces



BLADE
*For difficult cuts thanks to its solid, wide serrated blade.



ERGONOMIC BODY
*Lightweight and durable thanks to ABS Plastic body.



LOCKING MECHANISM
*The screw lock mechanism allows the blade length to be adjusted to the desired level during the cutting process.



HANGER SLOT
*It is an easily portable product thanks to its hanging slot.

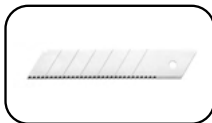

BLADE

*Snap off and serrated blade distributes friction over a wider surface, making it easier for tough cuts.

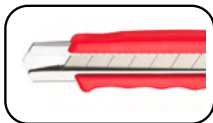

BODY

*ABS Plastic body is comfortable, long-lasting and durable thanks to its ergonomic structure.



LOCKING MECHANISM AND HANGING SLOT

* The screw lock mechanism allows the blade length to be adjusted to the desired level during the cutting process.
* It is an easily portable product thanks to the hanger slot.

VT875125T

DIMENSIONS (MM)

18x46x195

KNIFE CODE / SIZE (MM)

VT877000-1 / 0,7x25x125

COLOR OPTIONS



Blade Features: SK-2 Steel - 6 Segments - Serrated

TECHNICAL FEATURES



SCREW LOCK



ABS PLASTIC



ERGONOMIC



HANGABLE



BREAKING OF BLADE

AREAS OF USE



PARQUET (HARDWOOD)



RUBBER



FELT



PLASTERBOARD



DRYWALL



PLASTIC PIPE



BASEBOARD



PIPE



TARPAULIN



AND MORE

PACKAGING FEATURES

BOX

(SIZE - QUANTITY)

28X18X16,5 cm

36 Pieces

PARCEL

(SIZE - QUANTITY)

58X38X35 cm

288 Pieces

PALLET

(SIZE - QUANTITY)

120X80X155 cm

4608 Pieces

VIP-TEC



STATIONERY - HOBBY



VT875113-1

DIMENSIONS (MM)

6x11x130

KNIFE CODE / SIZE (MM)

VT876001 / 0,4x9x74

Blade Features: SK-3 Steel - 6 Segments - Double Cutting Edge - 30 Degree Angle

TECHNICAL FEATURES



AUTO-LOCK
MECHANISM



ERGONOMIC



FOR BOTH
HANDS
CAN BE USED
WITH EITHER HAND



CLIPS

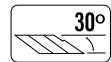

30 DEGREE ANGLE BLADE

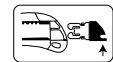

BREAKING OF BLADE

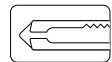

STAINLESS STEEL

AREAS OF USE



PAPER



CARDBOARD



WINDOW FILM



BAGGED
PRODUCTS



FOIL



YARN



HAND CRAFT
FOIL



NYLON



BUBBLE WRAP



PLASTIC
PACKAGE



RUBBER



AND MORE

PACKAGING FEATURES

BOX

(SIZE - QUANTITY)

19x18x15 cm

36 Pieces

PARCEL

(SIZE - QUANTITY)

56X39X31 cm

432 Pieces

PALLET

(SIZE - QUANTITY)

120x80x170 cm

8640 Pieces



STAINLESS STEEL BODY

*Stainless steel body provides light weight and corrosion resistance.



LOCK MECHANISM

*The automatic locking mechanism ensures safe use by keeping the blade completely fixed and locked during the cutting process.



CLIP

*The clip on the back provides ease of transportation and blade snap off operation.

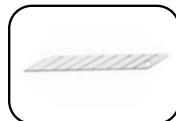

BLADE

*30 Degree angled blade provides ease of precision cutting operations.



BLADE

*The hook-shaped blade is designed to separate plastic surfaces when it reaches sufficient depth.



BODY

*Provides ergonomic use thanks to its ABS Plastic body.



SPARE COMPARTMENT

*It has an opening structure where you can store spare blades at the back.

VT875140

DIMENSIONS (MM)

L:154mm

KNIFE CODE / SIZE (MM)

VT873005-1 / 0,6x10,5x46

Blade Features: SK-2 Steel

TECHNICAL FEATURES



ABS PLASTIC



ERGONOMIC



HANGABLE

AREAS OF USE



PVC



PARQUET (HARDWOOD)



MEMBRANE



AND MORE

PACKAGING FEATURES

BOX

(SIZE - QUANTITY)

24,5x11X17 cm

36 Pieces

PARCEL

(SIZE - QUANTITY)

56x26x36 cm

360 Pieces

PALLET

(SIZE - QUANTITY)

120x80x122 cm

6480 Pieces

VT875150

DIMENSIONS (MM)
11x28x157

KNIFE CODE / SIZE (MM)
VT877010-1 / 0,3x28

COLOR OPTIONS

Blade Features: SKS-7 Steel

TECHNICAL FEATURES



SCREW LOCK



ABS PLASTIC



SAFETY



ERGONOMIC



HANGABLE



CAN BE USED WITH EITHER HAND

AREAS OF USE



LEATHER



TEXTILE



PAPER



HAND CRAFT FOIL



FOIL



AND MORE

PACKAGING FEATURES

BOX
(SIZE - QUANTITY)

28X18X16,5 cm

24 Pieces

PARCEL
(SIZE - QUANTITY)

58X38X35 cm

192 Pieces

PALLET
(SIZE - QUANTITY)

120X80X155 cm

3072 Pieces



LOCKING MECHANISM

*The screw lock system is used for changing and fixing the cutting blade.



SAFETY

*It has a sliding safety cover for when not in use.



ERGONOMIC BODY

*Lightweight and easy to use thanks to ABS Plastic body.



HANGING SLOT

*Provides ease of transportation.

VT875151

DIMENSIONS (MM)

17x45x178

KNIFE CODE / SIZE (MM)

VT877015-1 / 0,3x45

COLOR OPTIONS

Blade Features: SKS-7 Steel

TECHNICAL FEATURES

SCREW LOCK



ABS PLASTIC



SAFETY



ERGONOMIC



HANGABLE

 CAN BE USED
WITH EITHER HAND

AREAS OF USE

LEATHER



TEXTILE



PAPER

 HAND CRAFT
FOIL

FOIL



AND MORE

PACKAGING FEATURES
BOX

(SIZE - QUANTITY)

28X18X16,5 cm

24 Pieces

PARCEL

(SIZE - QUANTITY)

58X38X35 cm

192 Pieces

PALLET

(SIZE - QUANTITY)

120X80X155 cm

3072 Pieces

LOCKING MECHANISM

*The screw lock system is used for changing and fixing the cutting blade.

SAFETY

*It has a sliding safety cover for when not in use.

ERGONOMIC BODY

*Lightweight and easy to use thanks to ABS Plastic body.

HANGING SLOT

*Provides ease of transportation.



SERRATED BLADE

*Serrated blade with one serrated edge to help prevent slipping while cutting.



STAINLESS STEEL BLADE

*Stainless steel blades are long lasting and corrosion resistant.

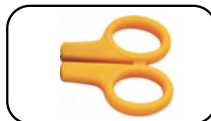

HANDLE

*Lightweight, long-lasting and ergonomic use thanks to ABS Plastic handle.

VT875160

DIMENSIONS (MM)

L: 141mm

Blade Features: Stainless Steel

TECHNICAL FEATURES



ABS PLASTIC



ERGONOMIC



CAN BE USED WITH EITHER HAND



STAINLESS STEEL

AREAS OF USE



PAPER



CARDBOARD



TEXTILE



HAND CRAFT FOIL



YARN



AND MORE

PACKAGING FEATURES

BOX

(SIZE - QUANTITY)

24,5x11x17 cm

24 Pieces

PARCEL

(SIZE - QUANTITY)

56x26x36 cm

240 Pieces

PALLET

(SIZE - QUANTITY)

120X80X122 cm

4320 Pieces

VT875165

DIMENSIONS (MM)

L: 180mm

Blade Features: Stainless Steel

TECHNICAL FEATURES

ABS

ABS PLASTIC



ERGONOMIC



RUBBER GRIP



CAN BE USED WITH EITHER HAND



STAINLESS STEEL

AREAS OF USE



PAPER



CARDBOARD



TEXTILE



HAND CRAFT FOIL



YARN



AND MORE

PACKAGING FEATURES

BOX

(SIZE - QUANTITY)

22X10X23,5 cm

24 Pieces

PARCEL

(SIZE - QUANTITY)

46X30X39 cm

192 Pieces

PALLET

(SIZE - QUANTITY)

120X80X134 cm

3456 Pieces



BLADE

*Light and precise cutting thanks to specially sharpened blades.



STAINLESS STEEL BLADE

*Corrosion-resistant stainless steel blade with long-lasting cutting ability.



HOLDING HANDLE

*Rounded and long handle for secure grip and easy handling.



PROTECTIVE CAP

*Increases safety and protection of the blade from damage when not in use.

VT875171

DIMENSIONS (MM)

8x148

KNIFE CODE / SIZE (MM)

VT873000-2 / 0,5x6x36

Blade Features: SK-5 Steel

TECHNICAL FEATURES



METAL



ERGONOMIC



SAFETY



CAN BE USED
WITH EITHER HAND

AREAS OF USE



PAPER



CARDBOARD



WINDOW FILM



BAGGED
PRODUCTS



NYLON



BUBBLE WRAP



FOIL



HAND CRAFT
FOIL



PLASTIC
PACKAGE



YARN



RUBBER



AND MORE

PACKAGING FEATURES

BOX

(SIZE - QUANTITY)

19X7X21 cm

20 Pieces

PARCEL

(SIZE - QUANTITY)

38X38X34 cm

280 Pieces

PALLET

(SIZE - QUANTITY)

120X80X150 cm

6720 Pieces



PROTECTIVE CAP

*Increases safety and protection of the blade from damage when not in use.

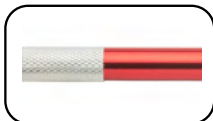

USE

*It has a textured surface that prevents slipping from the hand.



ALUMINUM METAL BODY

*Lightweight and corrosion resistant.



PROTECTIVE CAP

*Increases safety and protection of the blade from damage when not in use.



USE

*The rubber coating on the metal body prevents slipping and provides a comfortable grip.



ALUMINUM METAL BODY

*Lightweight and corrosion resistant.

VT875172

DIMENSIONS (MM)

12x156

KNIFE CODE / SIZE (MM)

VT873000 / 0,5x8x40

Blade Features: SK-5 Steel

TECHNICAL FEATURES



METAL



ERGONOMIC



SAFETY



RUBBER GRIP



CAN BE USED WITH EITHER HAND

AREAS OF USE



PAPER



CARDBOARD



WINDOW FILM



BAGGED PRODUCTS



NYLON



BUBBLE WRAP



FOIL



HAND CRAFT FOIL



PLASTIC PACKAGE



YARN



RUBBER



AND MORE

PACKAGING FEATURES

BOX

(SIZE - QUANTITY)

20,5X10X21 cm

20 Pieces

PARCEL

(SIZE - QUANTITY)

58X38X35 cm

240 Pieces

PALLET

(SIZE - QUANTITY)

120X80X155 cm

3840 Pieces



LOCK AND SAFETY

*Features a stainless steel blade that slides back safely when the lockable mechanism is released when open.

*Safe light-duty use and easy transportation thanks to its mini size.

VT875155

DIMENSIONS (MM)

12x30x62

TECHNICAL FEATURES



ABS PLASTIC



ERGONOMIC



SAFETY



HANGABLE



CAN BE USED WITH EITHER HAND

AREAS OF USE



PAPER



HAND CRAFT FOIL



BUBBLE WRAP



PLASTIC PACKAGE



STRETCH FILM



TAPE



AND MORE

PACKAGING FEATURES

BOX

(SIZE - QUANTITY)

12X11,5X7 cm

10 Pieces

PARCEL

(SIZE - QUANTITY)

38X38X34 cm

450 Pieces

PALLET

(SIZE - QUANTITY)

120X80X150 cm

10800 Pieces



CLOTH BAG

* There is a cloth bag that prevents damage to the products and provides ease of transportation.



PRODUCT CONTENTS

- *VT875150 / Round Cutting Knife 28mm
- *VT875172 / Hobby Knife Black 8x145mm
- *VT875113-1 / 9mm Utility Knife with Clip 30 Degree Angled Blade
- *VT8756001 / 9mm Utility Knife Refill 30 Degree Angled - Thickness : 0.40mm 1 Tube : 10 Pieces
- *VT875165 / Professional Scissors - 18 cm
- *VT8753000 / Hobby Knife Spare Thickness : 0.30mm - 1 Tube: 10 Pieces

H653000-01

TECHNICAL FEATURES



ERGONOMIC

AREAS OF USE



PAPER



CARDBOARD



WINDOW FILM



BAGGED PRODUCTS



FOIL



HAND CRAFT FOIL



NYLON



BUBBLE WRAP



STRETCH FILM



YARN



TAPE



AND MORE

PACKAGING FEATURES

BOX
(SIZE - QUANTITY)

25x12x3 cm

1 Piece

PARCEL
(SIZE - QUANTITY)

38x38x34 cm

50 Pieces

PALLET
(SIZE - QUANTITY)

120x80x150 cm

1200 Pieces

TRAPEZOID AND HOOK CUTTERS





VT875108



VT875121



ERGONOMIC BODY

*It has a light and durable structure thanks to its ABS Plastic body.



SLIDER AND SCREW

*Provides cutting at different depths with three-stage slider.

* Blade change is carried out via the screw part.



ASKI BHANGAR SLOT

*Provides ease of product storage and transportation.

VT875108 - VT875121

DIMENSIONS (MM)

18x33x150

KNIFE CODE / SIZE (MM)

VT874000 / 0,6x19x60
VT874001 / 0,6x19x48

COLOR OPTIONS



Blade Features: SK-2 Steel - Trapezoid/Hook - Double Cutting Edge

TECHNICAL FEATURES



AUTO-LOCK MECHANISM



ABS PLASTIC



ERGONOMIC



TRAPEZ



HANGABLE



CAN BE USED WITH EITHER HAND



DEPTH OF CUT 16mm HOOKED

AREAS OF USE



CARPET



LEATHER



CARDBOARD



TEXTILE



PIPE



UPHOLSTERY



MEMBRANE



AND MORE

PACKAGING FEATURES

BOX

(SIZE - QUANTITY)

24,5x11x17 cm

36 Pieces

PARCEL

(SIZE - QUANTITY)

56x26x36 cm

360 Pieces

PALLET

(SIZE - QUANTITY)

120X80X122 cm

6480 Pieces



VT875128



VT875129



ALUMINUM METAL BODY
*Lightweight and corrosion resistant thanks to its aluminum body.







SLIDER AND SCREW
*Provides cutting at different depths with three-stage slider.
*Blade change is carried out from the screw part.









HANGER SLOT
*Provides ease of product storage and transportation.

VT875128 - VT875129









DIMENSIONS (MM) 21x33x150	KNIFE CODE / SIZE (MM) VT874000 / 0,6x19x60 VT874001 / 0,6x19x48	COLOR OPTIONS    
-------------------------------------	-------------------------------------------------------------------------------	-------------------------------------------------------------------------------------------------------------------------------------------------------------------------------------------------------------------------------------------------------------------------------------------------------------------------------------------------------------------------

Blade Features: SK-2 Steel - Trapezoid/Hook - Double Cutting Edge

TECHNICAL FEATURES

 AUTO-LOCK MECHANISM	 METAL	 ERGONOMIC	 TRAPEZ
 HANGABLE	 CAN BE USED WITH EITHER HAND	 18mm DEPTH OF CUT TRAPEZOID	

AREAS OF USE

 CARPET	 LEATHER	 CARDBOARD	 TEXTILE
 PIPE	 UPHOLSTERY	 MEMBRANE	 AND MORE

PACKAGING FEATURES

BOX (SIZE - QUANTITY)	PARCEL (SIZE - QUANTITY)	PALLET (SIZE - QUANTITY)
24,5x11x17 cm 36 Pieces	36X26X34 cm 216 Pieces	120X80X117 cm 5832 Pieces

SCRAPERS





PROTECTIVE CAP

*Increases safety and protection of the blade from damage when not in use.



ERGONOMIC BODY

*ABS Plastic body provides convenience during use.

VT875123

DIMENSIONS (MM)

L: 180mm

KNIFE CODE / SIZE (MM)

VT874000 / 0,6x19x60

COLOR OPTIONS



Blade Features: SK-2 Steel - Trapezoid - Double Cutting Edge

TECHNICAL FEATURES



ABS PLASTIC



ERGONOMIC



HANGABLE



CAN BE USED WITH EITHER HAND



SAFETY

AREAS OF USE



FLOOR SCRAPING



PAINT SCRAPING



FLOOR AND WALL CERAMICS



LABEL



AND MORE

PACKAGING FEATURES

BOX

(SIZE - QUANTITY)

26X19X11 cm

36 Pieces

PARCEL

(SIZE - QUANTITY)

58X28X48 cm

432 Pieces

PALLET

(SIZE - QUANTITY)

120X80X158 cm

7776 Pieces



VT875130Y



VT875130YP



PROTECTIVE CAP
*Increases safety and protection of the blade from damage when not in use.



ERGONOMIC BODY
*ABS Plastic body provides convenience during use.



METAL BLADE
*Use the metal blade for scraping in difficult areas.



PLASTIC BLADE
*Use the plastic blade for scraping in sensitive areas and to prevent damage to the surface.

VT875130Y - VT875130YP

DIMENSIONS (MM)
6x42x109

KNIFE CODE / SIZE (MM)
VT879000 / 0,25x19x38
VT879000-1 / 1,2x19x38

COLOR OPTIONS
● ● ● ●

Blade Features: SK-2 Steel / PLASTIC

TECHNICAL FEATURES



ABS PLASTIC



ERGONOMIC



HANGABLE



CAN BE USED WITH EITHER HAND



SAFETY

AREAS OF USE



FLOOR SCRAPING



FLOOR AND WALL CERAMICS



PAINT SCRAPING



ICE SCRAPING



WINDOW FILM



VEHICLE WRAP



LABEL



AND MORE

PACKAGING FEATURES

BOX
(SIZE - QUANTITY)

18X14X7 cm
12 Pieces

PARCEL
(SIZE - QUANTITY)

39X38X30 cm
240 Pieces

PALLET
(SIZE - QUANTITY)

120X80X135 cm
5760 Pieces

VT875131

DIMENSIONS (MM)
18x110x160

KNIFE CODE / SIZE (MM)
VT875000 / 0,5x18x100

COLOR OPTIONS

Blade Features: SK-2 Steel - 7 Segments - Double Cutting Edge

TECHNICAL FEATURES



ABS PLASTIC



ERGONOMIC



HANGABLE



CAN BE USED WITH EITHER HAND



SAFETY

AREAS OF USE



FLOOR SCRAPING



PAINT SCRAPING



FLOOR AND WALL CERAMICS



LABEL



AND MORE

PACKAGING FEATURES

BOX
(SIZE - QUANTITY)

21X14X20 cm
12 Pieces

PARCEL
(SIZE - QUANTITY)

58X43X44 cm
192 Pieces

PALLET
(SIZE - QUANTITY)

120X100X146 cm
2880 Pieces



PROTECTIVE CAP
*Increases safety and protection of the blade from damage when not in use.



SCRAPING WIDTH
*It has a blade width of 100mm for scraping large surfaces.



ERGONOMIC BODY
*ABS Plastic body provides convenience during use.



PROTECTIVE CAP
*For easy blade replacement, you can replace the worn-out spare blade by pressing the button.



PROTECTIVE CAP

*Increases safety and protection of the blade from damage when not in use.



ALUMINUM METAL BODY AND BLADE REPLACEMENT

*Aluminum metal body provides long term use.
*Corrosion resistant.
*You can replace the worn blade by loosening the screw on it.



HOLDING HANDLE

*Ergonomic design thanks to ABS Plastic body.

VT875132

DIMENSIONS (MM)

L: 215mm

KNIFE CODE / SIZE (MM)

VT875000 / 0,5x18x100

COLOR OPTIONS



Blade Features: SK-2 Steel - 7 Segments - Double Cutting Edge

TECHNICAL FEATURES



METAL



ERGONOMIC



HANGABLE



CAN BE USED WITH EITHER HAND



SAFETY

AREAS OF USE



FLOOR SCRAPING



PAINT SCRAPING



FLOOR AND WALL CERAMICS



SIGN



AND MORE

PACKAGING FEATURES

BOX

(SIZE - QUANTITY)

37X26X15 cm

12 Pieces

PARCEL

(SIZE - QUANTITY)

37X26X15 cm

12 Pieces

PALLET

(SIZE - QUANTITY)

120X80X165 cm

1080 Pieces

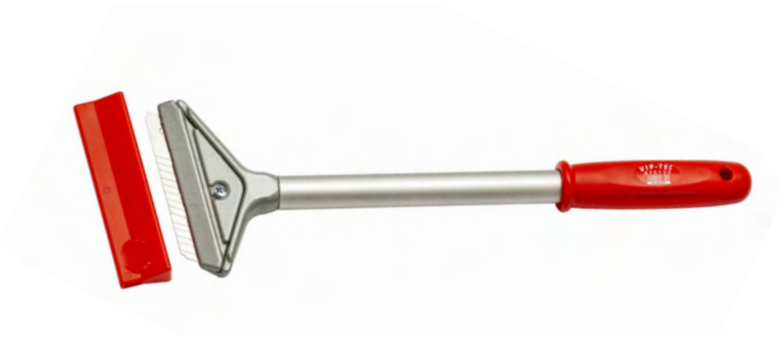

VT875133

DIMENSIONS (MM)

L: 365mm

KNIFE CODE / SIZE (MM)

VT875000 / 0,5x18x100

COLOR OPTIONS



Blade Features: SK-2 Steel - 7 Segments - Double Cutting Edge

TECHNICAL FEATURES



METAL



ERGONOMIC



HANGABLE



CAN BE USED WITH EITHER HAND



SAFETY

AREAS OF USE



FLOOR SCRAPING



PAINT SCRAPING



FLOOR AND WALL CERAMICS



SIGN



AND MORE

PACKAGING FEATURES

BOX
(SIZE - QUANTITY)

50X16X18 cm

12 Pieces

PARCEL
(SIZE - QUANTITY)

50X16X18 cm

12 Pieces

PALLET
(SIZE - QUANTITY)

120X80X175 cm

1188 Pieces



PROTECTIVE CAP

*Increases safety and protection of the blade from damage when not in use.



ALUMINUM METAL BODY AND BLADE REPLACEMENT

*Aluminum metal body provides long term use.
*Corrosion resistant.
*You can replace the worn blade by loosening the screw on it.



ALUMINUM HANDLE

*The long aluminum handle makes it easy to scrape in hard-to-reach areas.



HOLDING HANDLE

*Ergonomic design thanks to ABS Plastic body.

VT875134

DIMENSIONS (MM)

L: 525mm

KNIFE CODE / ÖLÇÜ (MM)

VT875000 / 0,5x18x100

COLOUR OPTIONS



Blade Features: SK-2 Steel - 7 Segments - Double Cutting Edge

TECHNICAL FEATURES



METAL



ERGONOMIC



HANGABLE



CAN BE USED
WITH EITHER HAND



SAFETY

AREAS OF USE



FLOOR
SCRAPING



PAINT
SCRAPING



FLOOR AND
WALL CERAMICS



SIGN



AND MORE

PACKAGING FEATURES

BOX
(SIZE - QUANTITY)

66X24X18 cm

12 Pieces

PARCEL
(SIZE - QUANTITY)

66X24X18 cm

12 Pieces

PALLET
(SIZE - QUANTITY)

120X80X157 cm

768 Pieces



PROTECTIVE CAP

*Increases safety and protection of the blade from damage when not in use.



ALUMINUM METAL BODY AND BLADE REPLACEMENT

*Aluminum metal body provides long term use.
*Corrosion resistant.
*You can replace the worn blade by loosening the screw on it.



ALUMINUM HANDLE

*The long aluminum handle makes it easy to scrape in hard-to-reach areas.



HOLDING HANDLE

*Ergonomic design thanks to ABS Plastic body.



VT875135

DIMENSIONS (MM)

L: 185mm

TECHNICAL FEATURES



ERGONOMIC



ABS PLASTIC



CAN BE USED WITH EITHER HAND

AREAS OF USE



SILICONE SCRAPING



AND MORE

PACKAGING FEATURES

BOX
(SIZE - QUANTITY)

36X26X34 cm

50 Pieces

PARCEL
(SIZE - QUANTITY)

36X26X34 cm

50 Pieces

PALLET
(SIZE - QUANTITY)

120X80X117 cm

1350 Pieces



METAL END

*Provides ease in silicone removal thanks to its metal scraping tip.



PLASTIC SCRAPER

*Used for surface cleaning operations.



SPARES

* Used to create the shape of rounded corners with 5 interchangeable tips of different sizes.



ALUMINUM METAL BODY

*Provides comfort during use with rubber coating on aluminum metal body.



TIP REPLACEMENT

*Old silicone can be replaced by unscrewing the allen head screw on the body.

VT875136

DIMENSIONS (MM)

88x150

TECHNICAL FEATURES



METAL



RUBBER GRIP



ERGONOMIC



CAN BE USED WITH EITHER HAND

AREAS OF USE



VEHICLE WRAP



WINDOW FILM



AND MORE

PACKAGING FEATURES

BOX
(SIZE - QUANTITY)

24,5x11x17 cm

12 Pieces

PARCEL
(SIZE - QUANTITY)

56x26x36 cm

120 Pieces

PALLET
(SIZE - QUANTITY)

120X80X122 cm

2160 Pieces

NOTE : SILICONE TIP NOT INCLUDED

BLACK SERIES





VT875112-B



VT875117-B

VT875112-B // VT875117-B

DIMENSIONS (MM)

24x11x140
16x36x165

KNIFE CODE / SIZE (MM)

VT876000-2 / 0,4x9x80
VT875002 / 0,5x18x100

Blade Features: **VT875112-B:** SK-2 Steel - 6 Segments - Double Cutting Edge
VT875117-B: SK-3 Steel - 7 Segments - Double Cutting Edge

TECHNICAL FEATURES



AUTO-LOCK
MECHANISM



METAL



ERGONOMIC



HANGABLE

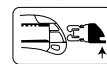

BREAKING OF BLADE

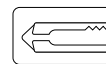

STAINLESS STEEL

AREAS OF USE



TAPE



FOIL



YARN



PAPER



CARDBOARD



VEHICLE
WRAP



STRETCH FILM



WINDOW FILM



TARPAULIN



WALL PAPER



PLASTIC
ZIP TIE



DRYWALL



PIPE



AND MORE

PACKAGING FEATURES

BOX

(SIZE - QUANTITY)

19x18x15 / 24x11x17 cm

36 / 36 Pieces

PARCEL

(SIZE - QUANTITY)

56X39X31 / 36x26x34 cm

432 / 216 Pieces

PALLET

(SIZE - QUANTITY)

120x80x170 / 120x80x117 cm

8640 / 5832 Pieces



VT875104-B



VT875125-B

VT875104-B // VT875125-B

DIMENSIONS (MM)

18x45x140
18x46x195

KNIFE CODE / SIZE (MM)

VT874000-4 / 0,6x19x60
VT877000-2 / 0,7x25x125

Blade Features: **VT875104-B:** SK-2 Steel - Trapezoid - Double Cutting Edge
VT875125-B: SK-3 Steel - 6 Segments - Double Cutting Edge

TECHNICAL FEATURES



QUICK RETURN
100mm



AUTOMATIC
SLIDE BACK

SAFETY



PRO
PROFESSIONAL

PROFESSIONAL



M

METAL



18mm
DEPTH OF CUT
TRAPEZOID

AREAS OF USE



TAPE



LEATHER



CARPET



CARDBOARD



TEXTILE



PIPE



UPHOLSTERY



TARPAULIN



RUBBER



FELT



STYROFOAM



DRYWALL



PARQUET



MEMBRANE



SHINGLE



AND MORE

PACKAGING FEATURES

BOX

(SIZE - QUANTITY)

24,5x11x17 / 28x18x16,5 cm

36 / 36 Pieces

PARCEL

(SIZE - QUANTITY)

36x26x34 / 58x38x35 cm

216 / 288 Pieces

PALLET

(SIZE - QUANTITY)

120x80x117 / 120x80x155 cm

5832 / 4608 Pieces

WHITE SERIES





VT875119-W



VT875114-W

VT875119-W // VT875114-W

DIMENSIONS (MM)

8x16x130
16x36x160

KNIFE CODE / SIZE (MM)

VT876000-6 / 0,4x9x80
VT875000-6 / 0,6x18x100

Blade Features: **VT875119-W:** Ceramic - 7 Segments - Double Cutting Edge
VT875114-W: Ceramic - 7 Segments - Double Cutting Edge

TECHNICAL FEATURES



AUTO-LOCK MECHANISM



ABS PLASTIC



CLIPS



BREAKING OF BLADE

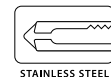

STAINLESS STEEL

AREAS OF USE



PAPER



CARDBOARD



WINDOW FILM



BAGGED PRODUCTS



FOIL



HAND CRAFT FOIL



NYLON



BUBBLE WRAP



YARN



TAPE



AND MORE

PACKAGING FEATURES

BOX

(SIZE - QUANTITY)

19x18x15 / 24x11x17 cm

36 / 36 Pieces

PARCEL

(SIZE - QUANTITY)

56x39x31 / 36x26x36 cm

432 / 360 Pieces

PALLET

(SIZE - QUANTITY)

120x80x170 / 120x80x122 cm

8640 / 6480 Pieces



VT875116-W



VT875125-W

VT875116-W // VT875125-W

DIMENSIONS (MM)

17x34x145
18x46x195

KNIFE CODE / SIZE (MM)

VT874000-6 / 0,6x19x60
VT877000-6 / 0,7x25x125

Blade Features: VT875116-W: Ceramic - Trapezoid - Double Cutting Edge
VT875125-W: Ceramic - 6 Segments - Double Cutting Edge

TECHNICAL FEATURES



PRO
PROFESSIONAL



ABS
ABS PLASTIC



QUICK RETURN
1MM
AUTOMATIC
SLIDE BACK



SAFETY



18mm
DEPTH OF CUT
TRAPEZOID



AUTO-LOCK
MECHANISM



BREAKING OF BLADE

AREAS OF USE



PAPER



CARDBOARD



BAGGED
PRODUCTS



FOIL



HAND CRAFT
FOIL



NYLON



BUBBLE WRAP



YARN



TAPE



AND MORE

PACKAGING FEATURES

BOX

(SIZE - QUANTITY)

24,5x11x17 / 28x18x16.5 cm

36 / 36 Pieces

PARCEL

(SIZE - QUANTITY)

56x29x36 / 58x38x35 cm

360 / 288 Pieces

PALLET

















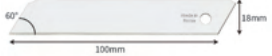









(SIZE - QUANTITY)















120x80x122 / 120x80x155 cm











6480 / 4608 Pieces

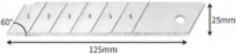











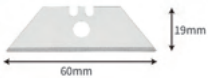







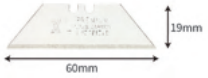



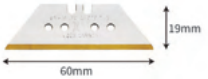

SPARE BLADES

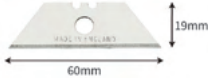











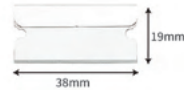



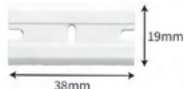



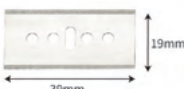



























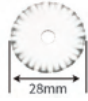





		TUBE/PIECE	PACK/PIECE	PARCEL/PIECE		
18MM	SPARE BLADE				FEATURES	
	VT875000		10	100	4.800	 WIDTH  DURABLE  SK-3 STEEL
	VT875000-1		10	100	4.800	 WIDTH  DURABLE  SK-3 STEEL
	VT875000-2		10	100	4.800	 WIDTH  DURABLE  SK-2 STEEL
	VT875003-1		10	100	4.800	 WIDTH  DURABLE  SK-5 STEEL
	VT875003-2		10	100	4.800	 WIDTH  DURABLE  SK-5 STEEL
	VT875004-1		10	100	4.800	 WIDTH  DURABLE  SK-5 STEEL













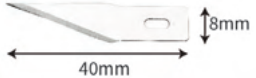

		TUBE/PIECE	PACK/PIECE	PARCEL/PIECE	
SPARE BLADE					FEATURES
9MM	VT876000 	10	100	10.000	  
	VT876000-1 	10	100	10.000	  
	VT876001 	10	100	10.000	  

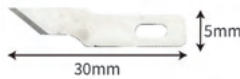











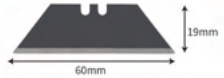





		TUBE/PIECE	PACK/PIECE	PARCEL/PIECE	
SPARE BLADE					FEATURES
25MM	VT877000 	10	300	2.400	 WIDTH  DURABLE  STEEL
	VT877000-1 	10	300	2.40	 WIDTH  DURABLE  STEEL













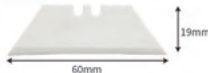



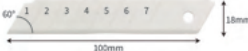

		TUBE/PIECE	PACK/PIECE	PARCEL/PIECE		
19MM	SPARE BLADE				FEATURES	
	VT874000		10	100	7.500	  
	VT8740001		10	100	7.500	  
	VT874000-1		10	100	7.500	  
	VT874000-2		10	100	7.500	  
	VT874000-3		10	100	7.500	  
	VT874000L		10	100	7.500	  

		TUBE/PIECE	PACK/PIECE	PARCEL/PIECE		
SPECIAL	SPARE BLADE				FEATURES	
	VT879000		8	80	6.000	  
	VT879000-1		4	40	3.000	  
	VT877020		10	100	7.500	  
	VT875005-1		10	40	4.800	  
	VT875005-2		5	50	1.800	  
	VT873005-1		10	100	4.800	  

		TUBE/PIECE	PACK/PIECE	PARCEL/PIECE		
ROUND	SPARE BLADE				FEATURES	
	VT877010-1		10	100	10.000	 0,3mm WIDTH  HARD DURABLE  SKS-7 STEEL
	VT877010-2		10	100	10.000	 0,3mm WIDTH  HARD DURABLE  SKS-7 STEEL
	VT877010-3		10	100	10.000	 0,3mm WIDTH  HARD DURABLE  SKS-7 STEEL
	VT877015-1		10	100	10.000	 0,3mm WIDTH  HARD DURABLE  SKS-7 STEEL
	VT877015-2		10	100	10.000	 0,3mm WIDTH  HARD DURABLE  SKS-7 STEEL
	VT877015-3		10	100	10.000	 0,3mm WIDTH  HARD DURABLE  SKS-7 STEEL

		TUBE/PIECE	PACK/PIECE	PARCEL/PIECE	
HOBBY	SPARE BLADE				FEATURES
	VT873000 	10	100	10.000	 WIDTH  WIDSHARP  SK-5 STEEL
	VT873000-1 	10	100	10.000	 WIDTH  WIDSHARP  SK-5 STEEL
	VT873000-2 	10	100	10.000	 WIDTH  WIDSHARP  SK-5 STEEL

		TUBE/PIECE	PACK/PIECE	PARCEL/PIECE		
BLACK	SPARE BLADE				FEATURES	
	VT874000-4		10	100	7.500	  
	VT875002		10	100	4.800	  
	VT876000-2		10	100	10.000	  
	VT877000-2		10	300	2.400	  

		TUBE/PIECE	PACK/PIECE	PARCEL/PIECE	FEATURES
CERAMIC	SPARE BLADE 				
	VT874000-6 	10	100	7.500	 0.6mm WIDTH  HARD DURABLE  SERAMIK ZIRCONIUM OXIDE (CERAMIC)
	VT875000-6 	10	100	4.800	 0.6mm WIDTH  HARD DURABLE  SERAMIK ZIRCONIUM OXIDE (CERAMIC)
	VT876000-6 	10	100	10.000	 0.5mm WIDTH  HARD DURABLE  SERAMIK ZIRCONIUM OXIDE (CERAMIC)
VT877000-6 	10	300	2.400	 0.7mm WIDTH  HARD DURABLE  SERAMIK ZIRCONIUM OXIDE (CERAMIC)	



19 mm SPARE



9 mm SPARE



18 mm SPARE



Blister



Body Sleeve



Standard Box



Display Box



Metal Stand

DIFFERENT
COLOUR
OPTIONS



OEM
PRINTING



DESIRED
BOX
DESIGN

AREAS OF USE



TECHNICAL FEATURES

